

060104

DATE: 21.4.2008

1(2)

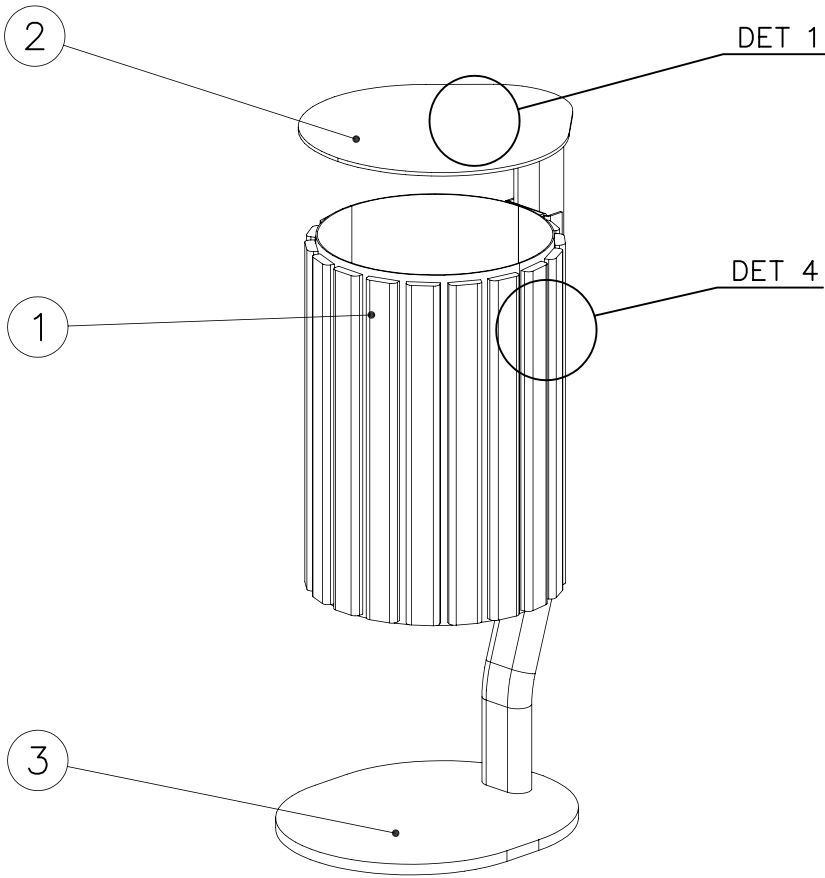



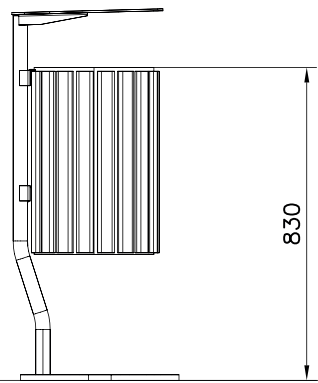
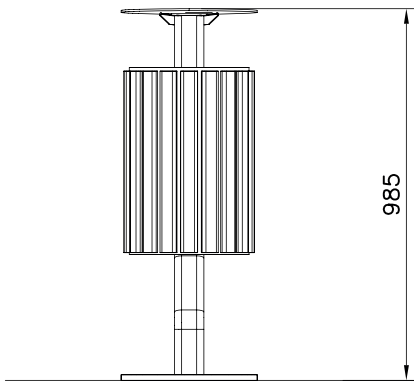



| | | | |
|----------|-----|----------|-----|
| ① | PCS | ② | PCS |
| | 1 | | 1 |
| ③ | PCS | ④ 909850 | PCS |
| | 1 | | 4 |
| ⑤ 909256 | PCS | ⑥ 980160 | PCS |
| | 8 | | 4 |
| Ø17/8.5 | | M8 | |
| | PCS | | PCS |
| | | | |
| | | | |

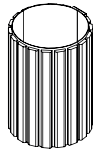
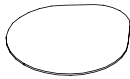
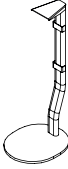
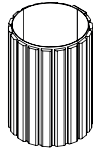

060104

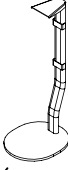
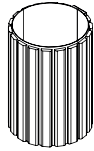
21.4.2008

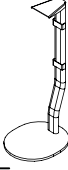
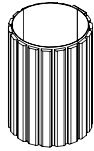
2(2)

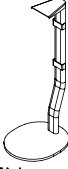
| | | | | | | | | |
|-----------|---|----------|---|----------|---|----------|--|-----|
| 060104 | 905304  | Pcs 1 | 905300  | Pcs 1 | 905331  | Pcs 1 | | Pcs |
| 060104-1 | 905304-1  GRAY | Pcs 1 | 905300-78  GRAY | Pcs 1 | 905331-78  GRAY | Pcs 1 | | Pcs |
| 060104-16 | 905304-16  CHERRY | Pcs 1 | 905300-80  BEIGE | Pcs 1 | 905331-80  BEIGE | Pcs 1 | | Pcs |
| 060104-17 | 905304-17  GREEN | Pcs 1 | 905300-79  GREEN | Pcs 1 | 905331-79  GREEN | Pcs 1 | | Pcs |

