

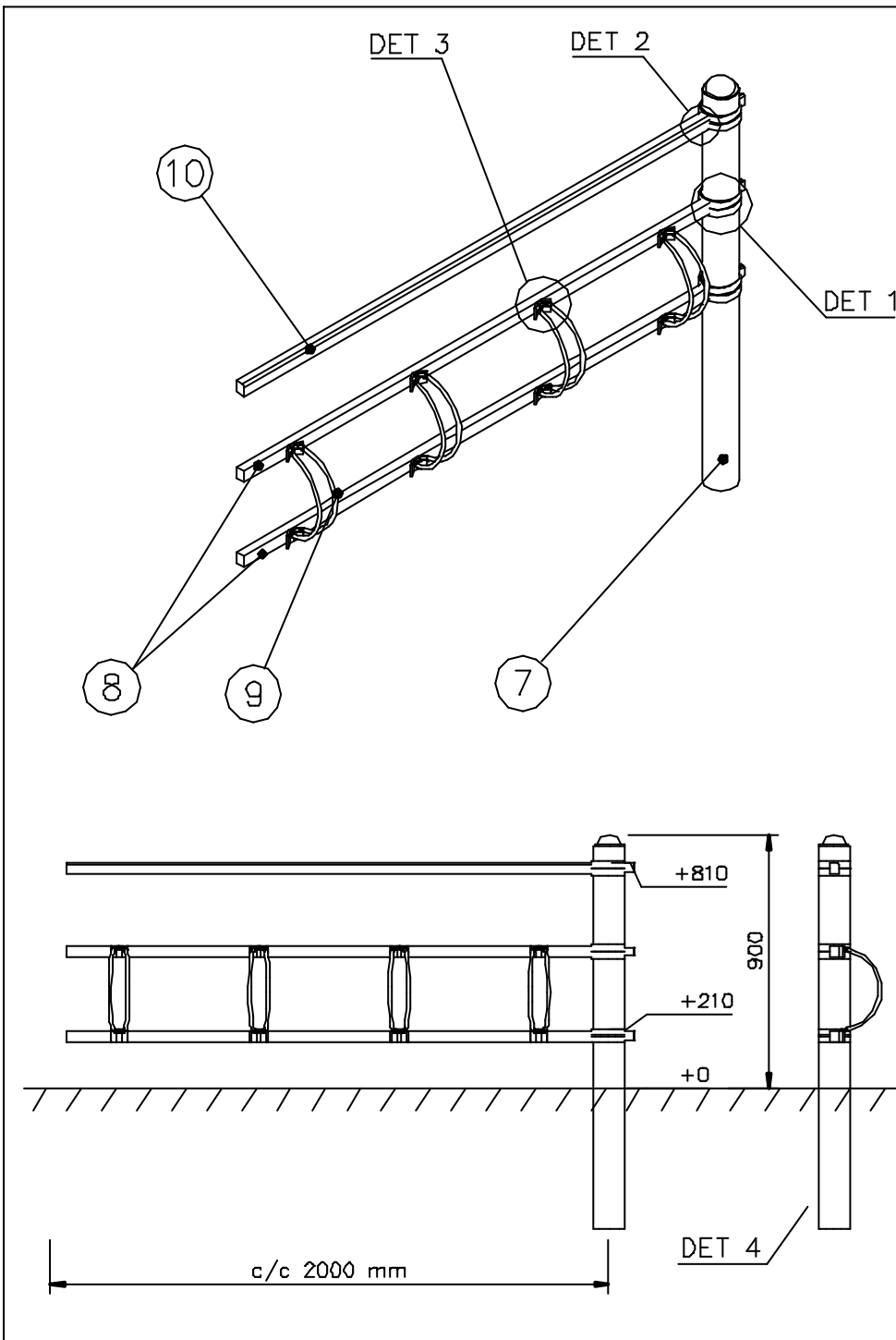











# NF9011

DATUM: 19.11.2004

1(1)

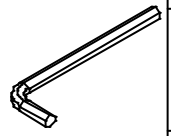

①	N00106	ST	②	N00126	ST
	8x20	6		M6x16	3
③	N01801	ST	④	N01812	ST
	M8	8		8x12	6
⑤	N01845	ST	⑥	N03816	ST
	8x45	8		8,4x16x1,5	14
⑦	N90001	ST	⑧	N90004	ST
	1			2	
⑨	N90005	ST	⑩	N90003	ST
	4			1	
⑪	N90008	ST	⑫	N00107	ST
	6			1	

